

Submittal Package

viega

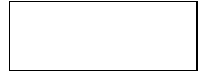

Viega PureFlow Poly PEX Press Fittings for Use with Viega PureFlow Tubing

Project:

Engineer:

Contractor:

Submitted By:

- Potable Water
- Other _____

Viega... The global leader in plumbing, heating and pipe joining systems

301 N. Main, 9th Floor • Wichita, KS 67202 • Ph: 800-976-9819 • Fax: 316-425-7618 • www.viega.com

©2011, ProPress®, FostaPEX®, Seapress®, MegaPress®, MegaPressG® and Viega® are registered trademarks of Viega GmbH & Co. PureFlow®, Smart Connect®, Climate Panel®, Climate Mat®, Climate Trak®, MANABLOC®, Radiant Wizard®, S-no-Ice®, Snap Panel®, XL® and XL-C® are registered trademarks of Viega LLC. MiniBloc™, ProRadiant™, PolyAlloy™, Poly PEX Press™, SmartLoop™ and Zero Lead™ are trademarks of Viega LLC; GeoFusion™, ProPressG™ and ViegaPEX™ are trademarks of Viega GmbH & Co. KG.

SM-PF 0911 (Poly PEX Press)

Submittal Package



Viega PureFlow Poly PEX Press Fittings for Use with Viega PureFlow Tubing

Technical Data

Materials:

Fittings.....	Radel-R® polymer
Press Sleeves.....	304 Stainless Steel
Poly PEX Press Manifolds.....	Radel-R® polymer
ViegaPEX, ViegaPEX Ultra Tubing.....	PEX (crosslinked polyethylene)
FostaPEX Tubing.....	PEX base tubing with aluminum and PE outer layers

Applications

This product specification designates the requirements for Viega PureFlow Poly PEX Press fittings with the Smart Connection feature and attached stainless steel press sleeves with tool locator ring to be used as connections for ViegaPEX, ViegaPEX Ultra, ViegaPEX Barrier, and FostaPEX tubing in 3/8", 1/2", 3/4", 1", 1-1/4", 1-1/2" and 2" sizes as available. The connections are to be completed with the aid of a Viega PureFlow PEX Press Hand Tool or Viega PureFlow PEX Press Power Tool.

Certifications

cNSF@us pw

- NSF International Performance and Health Effects (Standards 14 & 61)
- NSF certified to CSA B137.5 (Canadian Standards Association)

NSF Certified to NSF-U.P. Code

- approved for Uniform Plumbing Code, listed to ASTM F876 / F877



- ICC ES-PMG™ 1038 / 1015 plumbing and heating systems

Installation

- Use only PureFlow tubing and approved tools to make connections
- Keep flame and excessive heat away from tubing and connections.
- Refer to the PureFlow Installation Manual for additional information.

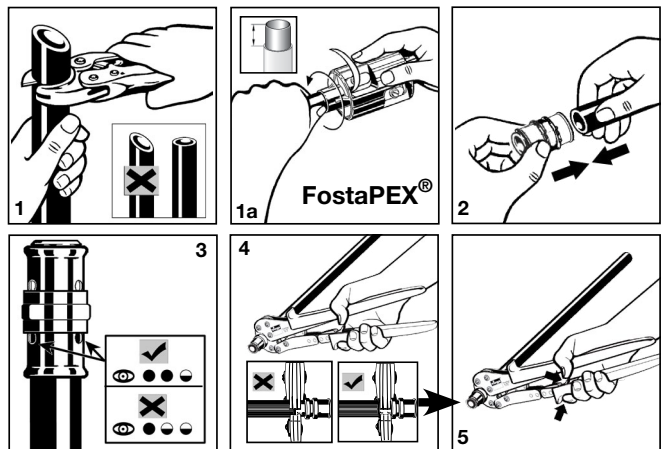

Viega... The global leader in plumbing, heating and pipe joining systems

301 N. Main, 9th Floor • Wichita, KS 67202 • Ph: 800-976-9819 • Fax: 316-425-7618 • www.viega.com

©2011, ProPress®, FostaPEX®, Seapress®, MegaPress®, MegaPressG® and Viega® are registered trademarks of Viega GmbH & Co. PureFlow®, Smart Connect®, Climate Panel®, Climate Mat®, Climate Trak®, MANABLOC®, Radiant Wizard®, S-no-Ice®, Snap Panel®, XL® and XL-C® are registered trademarks of Viega LLC. MiniBloc™, ProRadiant™, PolyAlloy™, Poly PEX Press™, SmartLoop™ and Zero Lead™ are trademarks of Viega LLC; GeoFusion™, ProPressG™ and ViegaPEX™ are trademarks of Viega GmbH & Co. KG.

Submittal Package



Viega PureFlow Poly PEX Press Fittings for Use with Viega PureFlow Tubing

ViegaPEX and ViegaPEX UltraTubing

Material.....PEX crosslinked polyethylene
 Temperature/Pressure Ratings...200°F at 80 psi
 180°F at 100 psi
 73.4°F at 160 psi
 Linear Expansion Rate.....1.1 in./100 ft./10°F

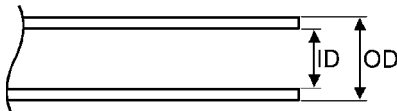

Nominal Size	Inner Diameter	Outer Diameter	Wall Thickness
3/8"	0.350	0.500±.003	0.070±.010
1/2"	0.475	0.625±.004	0.070±.010
3/4"	0.671	0.875±.004	0.097±.010
1"	0.863	1.125±.005	0.125±.013
1-1/4"	1.053	1.375±.005	0.153±.015
1-1/2"	1.243	1.625±.006	0.181±.019
2"	1.629	2.125±.006	0.236±.024

FostaPEX Tubing

Material.....PEX crosslinked polyethylene with aluminum and PE outer layers
 Temperature/Pressure Ratings...200°F at 80 psi
 180°F at 100 psi
 73.4°F at 160 psi
 Linear Expansion Rate.....0.16 in./100 ft./10°F

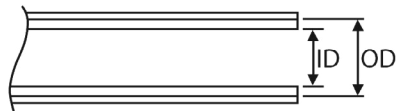

Nominal Size	Inner Diameter	Outer Diameter	Wall Thickness
1/2"	0.475	0.625±.004	0.070±.010
3/4"	0.671	0.875±.004	0.097±.010
1"	0.863	1.125±.005	0.125±.013

NOTE: Dimensions are in English units. Tolerances shown are ASTM requirements. FostaPEX is manufactured within these specifications. (These dimensions do not reflect the outer aluminum and PE layers.)

Viega... The global leader in plumbing, heating and pipe joining systems

301 N. Main, 9th Floor • Wichita, KS 67202 • Ph: 800-976-9819 • Fax: 316-425-7618 • www.viega.com

©2011, ProPress®, FostaPEX®, Seapress®, MegaPress®, MegaPressG® and Viega® are registered trademarks of Viega GmbH & Co. PureFlow®, Smart Connect®, Climate Panel®, Climate Mat®, Climate Trak®, MANABLOC®, Radiant Wizard®, S-no-Ice®, Snap Panel®, XL® and XL-C® are registered trademarks of Viega LLC. MiniBloc™, ProRadiant™, PolyAlloy™, Poly PEX Press™, SmartLoop™ and Zero Lead™ are trademarks of Viega LLC; GeoFusion™, ProPressG™ and ViegaPEX™ are trademarks of Viega GmbH & Co. KG.

Submittal Package

viega

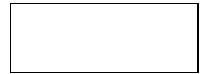

Viega PureFlow Poly PEX Press Fittings for Use with Viega PureFlow Tubing

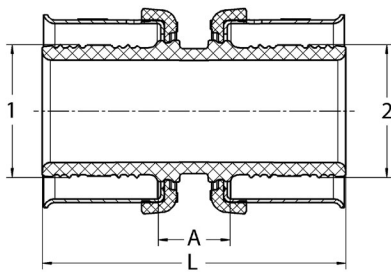

Viega Poly PEX Press Coupling

Stock Code	Size	A (in)	L (in)
	1 2		
49402	3/8"	0.469	1.661
49342	1/2" x 3/8"	0.417	1.610
49403	1/2"	0.469	1.661
49404	3/4"	0.469	1.661
49343	3/4" x 1/2"	0.429	1.622
49354	1" x 3/4"	0.469	1.819
49405	1"	0.469	1.976
49347	1-1/4" x 3/4"	0.654	2.339
49357	1-1/4" x 1"	0.484	2.327
49407	1-1/4"	0.512	2.693
49348	1-1/2" x 3/4"	0.685	2.370
49358	1-1/2" x 1"	0.622	2.465
49378	1-1/2" x 1-1/4"	0.654	2.339
49408	1-1/2"	0.512	2.693

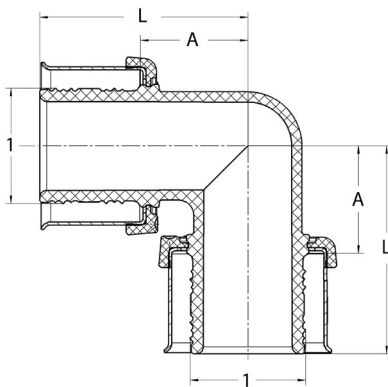

Viega Poly PEX Press Elbow

Stock Code	Size	A (in)	L (in)
	1		
49210	3/8"	0.512	1.106
49220	1/2"	0.512	1.106
49240	3/4"	0.677	1.272
49260	1"	0.768	1.520
49270	1-1/4"	0.980	2.075
49280	1-1/2"	1.095	2.189

Viega... The global leader in plumbing, heating and pipe joining systems

301 N. Main, 9th Floor • Wichita, KS 67202 • Ph: 800-976-9819 • Fax: 316-425-7618 • www.viega.com

©2011, ProPress®, FostaPEX®, Seapress®, MegaPress®, MegaPressG® and Viega® are registered trademarks of Viega GmbH & Co. PureFlow®, Smart Connect®, Climate Panel®, Climate Mat®, Climate Trak®, MANABLOC®, Radiant Wizard®, S-no-Ice®, Snap Panel®, XL® and XL-C® are registered trademarks of Viega LLC. MiniBloc™, ProRadiant™, PolyAlloy™, Poly PEX Press™, SmartLoop™ and Zero Lead™ are trademarks of Viega LLC; GeoFusion™, ProPressG™ and ViegaPEX™ are trademarks of Viega GmbH & Co. KG.

Submittal Package

viega

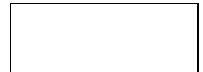

Viega PureFlow Poly PEX Press Fittings for Use with Viega PureFlow Tubing

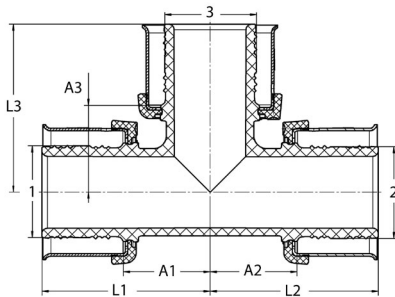

Viega Poly PEX Press Tee

Stock Code	Size	A1 (in)	A2 (in)	A3 (in)	L1 (in)	L2 (in)	L3 (in)
	1 2 3						
49200	3/8"	0.512	0.512	0.512	1.106	1.106	1.106
49322	1/2" x 3/8" x 3/8"	0.492	0.441	0.535	1.087	1.035	1.130
49332	1/2" x 1/2" x 3/8"	0.492	0.492	0.535	1.087	1.087	1.130
49520	1/2"	0.512	0.512	0.512	1.106	1.106	1.106
49334	1/2" x 1/2" x 3/4"	0.669	0.669	0.598	1.264	1.264	1.193
49433	3/4" x 1/2" x 1/2"	0.587	0.492	0.685	1.181	1.087	1.280
49443	3/4" x 3/4" x 1/2"	0.587	0.587	0.685	1.181	1.181	1.280
49434	3/4" x 1/2" x 3/4"	0.705	0.705	0.705	1.299	1.299	1.299
49540	3/4"	0.705	0.705	0.705	1.299	1.299	1.299
49533	1" x 1/2" x 1/2"	0.587	0.492	0.744	1.339	1.087	1.339
49543	1" x 3/4" x 1/2"	0.598	0.587	0.744	1.350	1.181	1.339
49544	1" x 3/4" x 3/4"	0.713	0.654	0.847	1.469	1.252	1.437
49535	1" x 1/2" x 1"	0.807	0.768	0.807	1.559	1.362	1.559
49545	1" x 3/4" x 1"	0.835	0.768	0.835	1.591	1.366	1.591
49553	1" x 1" x 1/2"	0.587	0.587	0.744	1.339	1.339	1.339
49554	1" x 1" x 3/4"	0.713	0.713	0.843	1.469	1.469	1.437
49560	1"	0.713	0.713	0.713	1.469	1.469	1.469
49754	1-1/4" x 1" x 3/4"	0.732	0.665	0.933	1.823	1.417	1.528
49755	1-1/4" x 1" x 1"	0.843	0.776	0.906	1.937	1.528	1.661
49774	1-1/4" x 1-1/4" x 3/4"	0.732	0.732	0.933	1.823	1.823	1.528
49775	1-1/4" x 1-1/4" x 1"	0.843	0.843	0.909	1.937	1.937	1.661
49570	1-1/4"	0.976	0.976	0.976	2.067	2.067	2.067
49854	1-1/2" x 1" x 3/4"	0.724	0.787	1.028	1.815	1.540	1.626
49855	1-1/2" x 1" x 1"	0.850	0.913	1.024	1.941	1.665	1.780
49884	1-1/2" x 1-1/2" x 3/4"	0.724	0.724	1.031	1.815	1.815	1.598
49885	1-1/2" x 1-1/2" x 1"	0.850	0.850	1.039	1.941	1.941	1.780
49887	1-1/2" x 1-1/2" x 1-1/4"	0.972	0.972	1.071	2.063	2.063	2.150
49580	1-1/2"	1.091	1.091	1.091	2.181	2.181	2.181

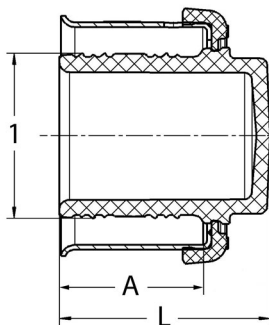

Viega Poly PEX Press Plug

Stock Code	Size	A (in)	L (in)
	1		
49722	3/8"	0.595	0.949
49723	1/2"	0.595	0.949
49744	3/4"	0.595	0.949
49765	1"	0.752	1.102

Viega... The global leader in plumbing, heating and pipe joining systems

301 N. Main, 9th Floor • Wichita, KS 67202 • Ph: 800-976-9819 • Fax: 316-425-7618 • www.viega.com

©2011, ProPress®, FostaPEX®, Seapress®, MegaPress®, MegaPressG® and Viega® are registered trademarks of Viega GmbH & Co. PureFlow®, Smart Connect®, Climate Panel®, Climate Mat®, Climate Trak®, MANABLOC®, Radiant Wizard®, S-no-Ice®, Snap Panel®, XL® and XL-C® are registered trademarks of Viega LLC. MiniBloc™, ProRadiant™, PolyAlloy™, Poly PEX Press™, SmartLoop™ and Zero Lead™ are trademarks of Viega LLC; GeoFusion™, ProPressG™ and ViegaPEX™ are trademarks of Viega GmbH & Co. KG.

Submittal Package

viega

Viega PureFlow Poly PEX Press Fittings for Use with Viega PureFlow Tubing

Viega Poly PEX Press MANABLOC Port Adapter

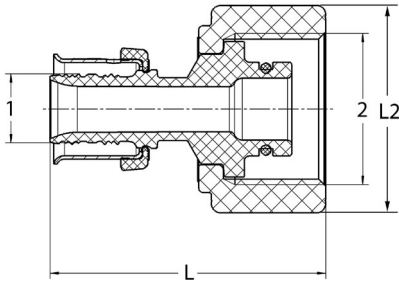

Stock Code	Size		L (in)	L2 (in)
	1	2		
49234	1/2" x 1/2" Port		1.890	1.4
49224	3/8" x 1/2" Port		1.890	1.4

Viega Poly PEX Press MANABLOC Supply Adapter

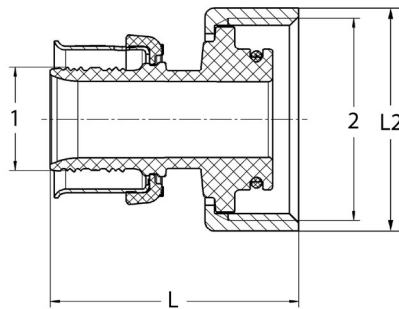

Stock Code	Size		L (in)	L2 (in)
	1	2		
49414	3/4" x 1" MANABLOC		1.59	1.45
49416	1" x 1" MANABLOC		1.75	1.45

Viega Poly PEX Press Lav Adapter

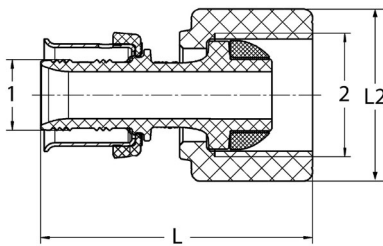

Stock Code	Size		L (in)	L2 (in)
	1	2		
49324	3/8" x 1/2" Lav		1.819	1.15
49333	1/2" x 1/2" Lav		1.819	1.15
49344	3/4" x 3/4" Lav		1.783	1.15

Viega Poly PEX Press Closet Adapter

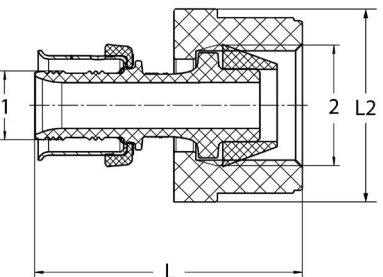

Stock Code	Size		L (in)	L2 (in)
	1	2		
49223	3/8" x 1/2" Closet		1.839	1.3
49233	1/2" x 1/2" Closet		1.839	1.3

Viega... The global leader in plumbing, heating and pipe joining systems

301 N. Main, 9th Floor • Wichita, KS 67202 • Ph: 800-976-9819 • Fax: 316-425-7618 • www.viega.com

©2011, ProPress®, FostaPEX®, Seapress®, MegaPress®, MegaPressG® and Viega® are registered trademarks of Viega GmbH & Co. PureFlow®, Smart Connect®, Climate Panel®, Climate Mat®, Climate Trak®, MANABLOC®, Radiant Wizard®, S-no-ice®, Snap Panel®, XL® and XL-C® are registered trademarks of Viega LLC. MiniBloc™, ProRadiant™, PolyAlloy™, Poly PEX Press™, SmartLoop™ and Zero Lead™ are trademarks of Viega LLC; GeoFusion™, ProPressG™ and ViegaPEX™ are trademarks of Viega GmbH & Co. KG.

Submittal Package

viega



Viega PureFlow Poly PEX Press Fittings for Use with Viega PureFlow Tubing

Viega Poly PEX Press Manifolds - Flow Through

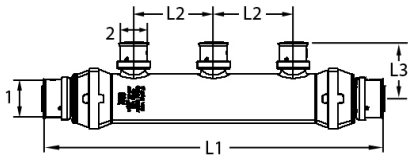

Stock Code	Size	L1 (in)	L2 (in)	L3 (in)
	1 2			
49152	3/4" x 1/2" (2 outlets)	6.58	2.00	1.42
49153	3/4" x 1/2" (3 outlets)	8.58	2.00	1.42
49054	3/4" x 1/2" (4 outlets)	10.58	2.00	1.42
49254	1" x 3/4" x 1/2" (4 outlets)	10.72	2.00	1.42
49256	1" x 1/2" (6 outlets)	14.85	2.00	1.42
49258	1" x 1/2" (8 outlets)	18.85	2.00	1.42

Viega Poly PEX Press Manifolds - Closed

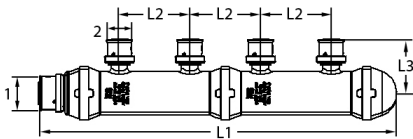

Stock Code	Size	L1 (in)	L2 (in)	L3 (in)
	1 2			
49004	3/4" x 1/2" (4 outlets)	10.14	2.00	1.42
49206	1" x 1/2" (6 outlets)	14.27	2.00	1.42

Viega... The global leader in plumbing, heating and pipe joining systems

301 N. Main, 9th Floor • Wichita, KS 67202 • Ph: 800-976-9819 • Fax: 316-425-7618 • www.viega.com

©2011, ProPress®, FostaPEX®, Seapress®, MegaPress®, MegaPressG® and Viega® are registered trademarks of Viega GmbH & Co. PureFlow®, Smart Connect®, Climate Panel®, Climate Mat®, Climate Trak®, MANABLOC®, Radiant Wizard®, S-no-Ice®, Snap Panel®, XL® and XL-C® are registered trademarks of Viega LLC. MiniBloc™, ProRadiant™, PolyAlloy™, Poly PEX Press™, SmartLoop™ and Zero Lead™ are trademarks of Viega LLC; GeoFusion™, ProPressG™ and ViegaPEX™ are trademarks of Viega GmbH & Co. KG.